

THE DeWALT RAFTER SQUARE

The DeWALT Rafter Square is designed to provide a quick, accurate, and repeatable means for laying out and cutting the various cuts on common, hip, valley and jack rafters used in roof construction.

Description

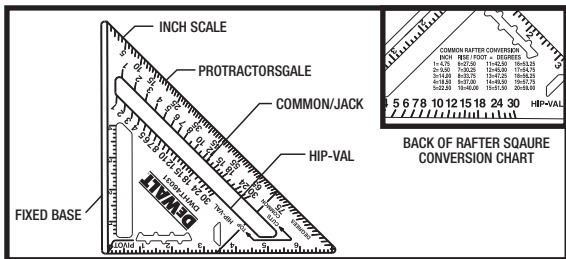

Features

- 1) Common/Jack and Hip/Valley rafter scales-Defined by inch rise per foot of run.
- 2) Protractor Scale-Graduated in degrees.
- 3) Inch Scale - 6-3/4" long graduated every 1/8 inch.
- 4) Extra wide, fixed base
- 5) Extra thick body ideal for use as a saw guide
- 6) 1/4" spaced notches for marking out scribing lines
- 7) Common rafter conversion chart

Using the DEWALT RAFTER SQUARE

Place the square on the face of the rafter, near the top end of the rafter. Pivot the square so that the number 6 (6" rise) on the common scale lines up with the rafter. While holding the pivot firmly against the rafter and keeping the number 6 lined up properly, mark your line, starting at the pivot point along the top edge of the square. This will be the top plumb cut line. (See Figure 2)

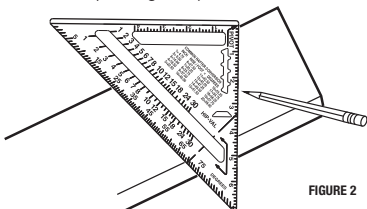

FIGURE 2

Illustration shows the square in position for marking the top plumb cut of a common rafter having a 6" rise, also showing a 26 1/2" degree angle.

Rafter Length

To find the length of a rafter (common, hip or valley) for a specific roof pitch and building width. First look up the required building width in Table 1. Next, find the desired rise in inches per foot of run (slope), in the left hand column, and read the exact rafter length length required to the right of the rise, under the column for the type of rafter desired.

Along the measuring line (refer to page 8), lay out and mark the length on the rafter.

Note: The length of rafters obtained from tables are to the center of the ridge. Therefore, half of the thickness of the ridge board should always be deducted from the listed rafter length before the top plumb cut is made. (See Figure 3)

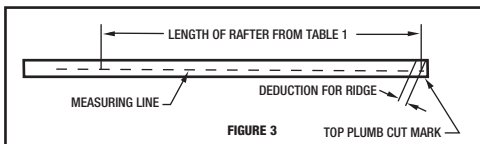

FIGURE 3

TOP PLUMB CUT MARK

Using DEWALT RAFTER SQUARE (continued)

The deduction of half the thickness of the ridge board is measured at right angles to the top plumb cut line and is marked parallel to the top plumb cut line.

A right angle line to the top plumb cut line is easily made with the The DEWALT Rafter Square.

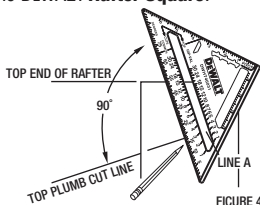

FIGURE 4

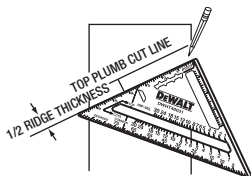

FIGURE 5

Simply line up A on the square so that it coincides with the top plumb cut line you just made. Your protractor scale edge will now be 90 degrees to your plumb cut line. Mark a line, along your protractor scale edge, on which you will measure and mark 1/2 your ridge thickness. (See Figure 4)

After marking 1/2 the ridge thickness, mark another line, through this mark, parallel to the original top plumb cut line. (See Figure 5)

NOTE: For jack rafter lengths, refer to pages 40 thru 44.

Seat Cuts

The seat cut is made perpendicular to the bottom plumb cut (heel cut) where it intersects the measuring line at a distance from the original top plumb cut line, equal to the rafter length.

To obtain the seat cut, construct another plumb cut line so that it crosses the measure line at the point that defines the rafter length. Line up line A on the square with the bottom plumb cut line made and move the square along this line until the edge of the square reaches the rafter length point on the measure line. Now mark a line from this point to the bottom of the square. This is your seat cut line. (See Figure 6A & 6B)

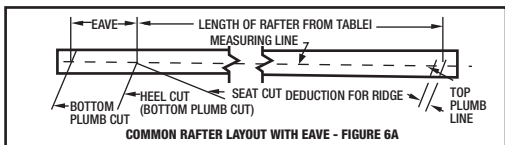

COMMON RAFTER LAYOUT WITH EAVE - FIGURE 6A

Using DEWALT RAFTER SQUARE (continued)

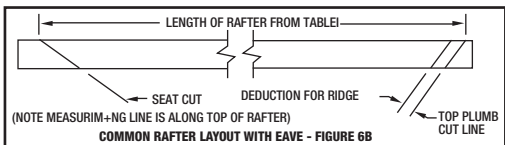

The preceding paragraphs in this section describe how to use the **Rafter Square** for making plumb, seat and heel cuts, determining the length of a rafter, and were general in nature.

Let's now take a look at an example for laying out and cutting common hip, valley and jack rafters for a specific building width and roof rise, the roof is also to have an overhang.

Building Specification

Width.....	20 feet
Rise.....	9 inches per foot run
Ridge.....	2 x 8 (1 ¹ / ₂ in. actual ridge thickness)
Eave Length.....	2 feet
Rafter Spacing.....	16 inch centers
Rafter Stock.....	2 x 6
Plate Stock.....	2 x 6

Common Rafter

1) Set the pivot of the DEWALT **Rafter Square** on the rafter edge. Rotate the square about the pivot point until the edge of the rafter lines up at '9' (between 8 and 10) on the scale for COM/JACK.



2) Mark the top plumb cut line at one end of the rafter.

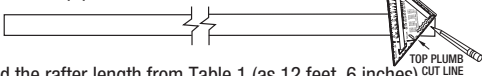

3) Find the rafter length from Table 1 (as 12 feet, 6 inches), and lay out and mark this length on the measuring line.

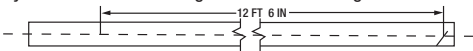

4) Subtract 1/2 of the thickness of the ridge board (in this case 3/4 inch) from the top plumb cut line.

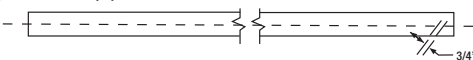

Using DEWALT RAFTER SQUARE (continued)

5) Mark a heel cut (bottom plumb cut line) and the seat cut lines.

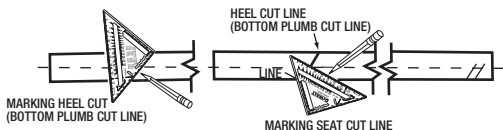

6) Add 2 feet, for the length of the eave, from the heel cut line along the measuring line and mark a bottom plumb cut line.

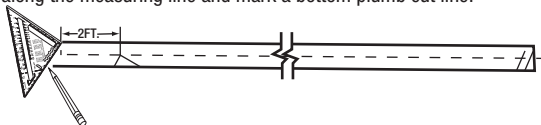

7) Once the rafter has been cut, it may now be used as a template for laying out the rest of the common rafters.



Hip and Valley Rafter

1) Set the pivot at the **Rafter Square** on the rafter edge. Rotate the square about the pivot point until the edge of the rafter lines up at '9' (between 8 and 10) on the scale for HIP/VAL.



2) Mark the top plumb cut line at one end at the rafter.

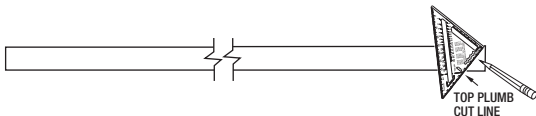

Using DeWALT RAFTER SQUARE (continued)

3) Rotate the **Rafter Square** and mark a line perpendicular to the top plumb cut line. Along this line measure and mark the thickness of the rafter.

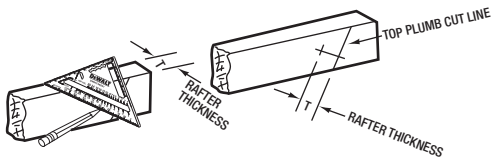

4) Make a second plumb cut mark at this point.

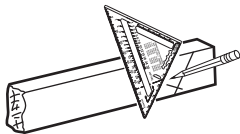

5) Set the **Rafter Square** on the top edge of the rafter. Extend both plumb cut marks square across the top of the rafter.

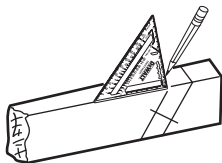

Using DeWALT RAFTER SQUARE (continued)

6) Connect opposite ends of the square lines, which will give the correct side cut angle. Note that rafters with opposite side cut angles will be required for opposing hip rafters and valley rafters.

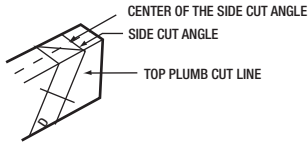

7) From the center of the side cut angle, lay out and mark the rafter length on the measuring line, as obtained from Table 1, (You will remember that we defined the measuring line on hip, valley and jack rafters as along the center line on top of the rafter.)

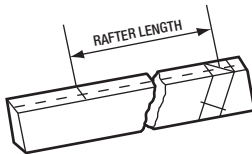

8) After marking the rafter length, mark a square line as shown above, Now mark a bottom plumb cut line on the side of the rafter as shown below left.

NOTE: If you are laying out a valley rafter, add a second plumb line 1/2 the thickness of the rafter from the plumb line just made, as shown below right. This is the line along which the heel cut will be made on the valley rafter to fit the intersecting plates.

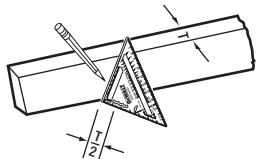
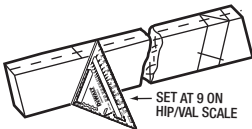

Using DEWALT RAFTER SQUARE (continued)

9) Measure the depth (D) at the heel cut from a common rafter, and mark the seat cut line by setting the pivot at the square on the edge of the rafter. Rotate the square about the pivot until the edge of the rafter lines up at the '9' on the HIP/VAL scale.

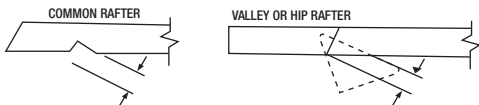

10) Now we move back to the top plumb cut line. The deduction for the ridge board thickness must be subtracted from the rafter length previously obtained from Table 1. Since the hip and valley rafters sit at an angle at 45 degrees to the ridge in the plan view, the thickness of the ridge board must be measured on a 45 degree diagonal line. Draw a 45 degree line across the top of the ridge board. Measure the length of the line and divide by 2. (In this case, the line should be $2\frac{1}{8}$ inches long-divided by 2 = $1\frac{1}{16}$ inch.)

11) Along the perpendicular line laid out in Step 3, page 33, and from the original top plumb cut line, measure and mark $1\frac{1}{16}$ inch. and at this mark make another top plumb cut line.

12) From the top at this top plumb cut line, draw another side cut line parallel to the side cut line made in Step 6). These last top plumb and side cut lines define the angle at which the end of the rafter is to be cut to fit flush against the ridge board.

Note that if a portable electric circular saw is used to cut this end of the rafter, that by tilting the blade at an angle of 45 degrees to the sole plate of the saw, and cutting along the top plumb cut line, the result will be the correct side cut angle. It is best to lay out the side cut angle on top of the rafter in any case, in order to be sure the tilt at the blade angle is in the right direction to result in the desired side cut.

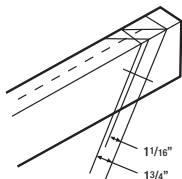

Using DeWALT RAFTER SQUARE (continued)

14) From the squared line across the top at the rafter at the bottom plumb cut line, measure and mark $30\frac{3}{4}$ inches (eave length). Square this line across the top of the rafter, and mark another bottom plumb cut line on the side of the rafter from this squared line.

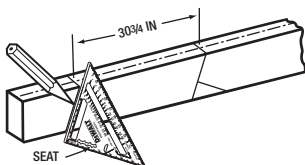

15) Since the length at the hip rafter and valley rafter are measured along the center line on top of the rafter, you can see that the corners at the bottom end of the eave are not in the same plane as the ends of the common rafters.

The cut-off length or the allowance for the mitre is half the thickness of the hip rafter as illustrated below in plan view.

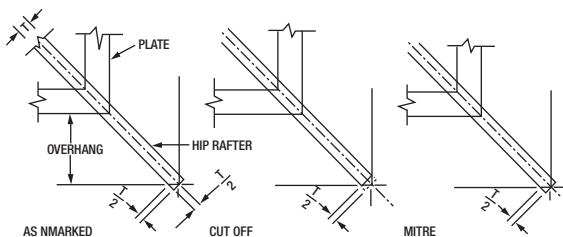

Using DEWALT RAFTER SQUARE (continued)

13) We must now consider the additional length that must be added to the length of the rafter to accommodate the eave. We calculate this by ratios. First, determine the length of common and hip/valley rafters for this pitch roof. In our example, the rafter length is 12' 6". The length of the hip rafter is 16' 1/8". The ratio of hip rafter length to common rafter length is:

$$\frac{16' 1/8''}{12' 6''} = \frac{(16 \times 12) + .125}{(12 \times 12) + 6} = \frac{192,125}{150} = 1.28$$

This ratio or the eave length at the hip or valley rafter divided by the eave length at the common rafter.

$$\frac{D}{C} = 1.28 \text{ where } D \text{ is the length of}$$

the hip or valley eave, and C is the length of the common rafter eave, as shown in the diagram below in our example:

$$\frac{D}{24''} = 1.28, \text{ then } D = 24'' \times 1.28 = 30.72''$$

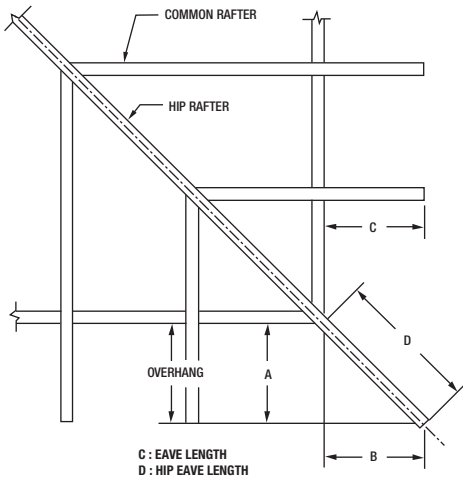

Using DeWALT RAFTER SQUARE (continued)

Some carpenters and roof framers prefer to mark and cut the eave after the hip rafter is in place by snapping a chalk line from the ends of the common rafters.

The cut-off is made along a plumb line laid out from the chalk mark, or as laid out to the calculated length above, with the blade of a portable electric saw set at an angle of 90 degrees to the soleplate.

The mitre cut is made along a plumb line with the blade of a portable electric saw set at an angle of 45 degrees to the soleplate.

16) In the case of the valley rafter, it is not necessary to foreshorten or mitre the end of the rafter since the measured length of the eave (measured along the top of the rafter) lies in the same plane as the ends of the common rafters, as shown in plan view below!

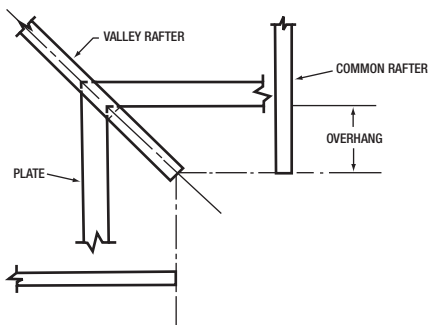

For those who want to make the effort, a 90 degree notch can be made at the bottom at the rafter to provide a better surface for fastening the fascia board. In this case, half the thickness of the valley rafter must be added to the length of the rafter, as illustrated below. A plumb line would again be drawn on the side of the rafter at this point, and with the blade set at 45 degrees on a portable electric saw, and at the proper depth, a cut is made along the plumb line on both sides of the rafter.

Using DEWALT RAFTER SQUARE (continued)

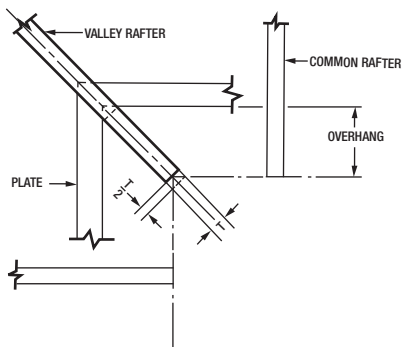

17) When building a hip roof the ridge board should be left about a foot longer than necessary at the ends. Then a common rafter, which has been cut to size, is placed on the center of the end plate, and the upper end positioned alongside the ridge board, aligning the top end of the common rafter with the top of the ridge board.

The ridge board is then marked at the end of the common rafter.

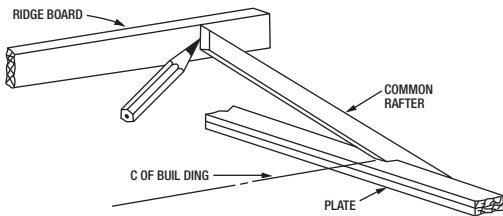

If a center common ridge rafter is used, the ridge board is cut to length at this mark, and the hip rafters are fastened at the top end of the common ridge rafter.

If no center common ridge rafter is used, add 2 inches to the length at the ridge board from the mark just made, to provide a surface to fasten the upper end of the hip rafter, and cut off the ridge board at this point.

Using DeWALT RAFTER SQUARE (continued)

Jack rafters

Jack rafters tie in the same plane as common rafters, and therefore have the same inch rise per foot run as common rafters.

1) At one end of the rafter, mark the top plumb cut line by setting the pivot of the DeWALT Rafter Square on the rafter edge and rotating the square about the pivot point until the edge of the rafter lines up at the '9' on the scale for COM/JACK.

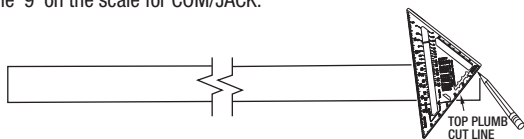

2) Mark a line perpendicular to the top plumb cut line, as shown in figure 4 page 30. Along this line measure and mark the thickness of the rafter.

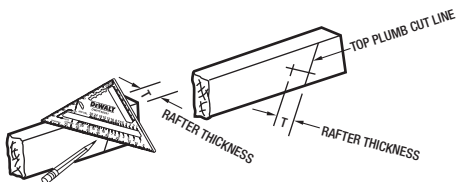

3) Mark a second plumb cut line at this point.

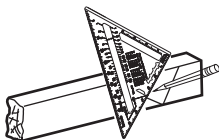

Using DeWALT RAFTER SQUARE (continued)

4) Square the top of the plumb lines across the top of the rafter. Note that in the case of a valley-jack rafter, the top of the rafter is on the 'short' side of the plumb line—that is, just the opposite side of a hipjack!

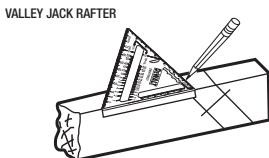
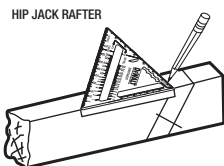

5) Depending on which way the side cut is to be made, connect opposite ends of the square lines.

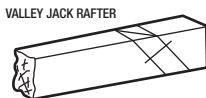
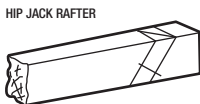

6) From Table 2, "Difference in Length of Jack Rafters for Various Spacing," the length given for 9 inch rise per foot run on 16 inch centers is 1 foot, 8 inches. This is also the length of the first, or shortest, hip-jack or valley-jack rafter. Each succeeding jack rafter will be 1 foot, 8 inches longer than the preceding one!

7) Along the measuring line (the center line on top of the rafter), and from the side cut line marked in Step 5), measure and mark the length of the rafter. The first rafter will be 1 foot, 8 inches long, the second rafter 3 feet, 4 inches long (2 times 1 foot, 8 inches), the third rafter 5 feet, 0 inches (3 times 1 foot, 8 inches), and so on!

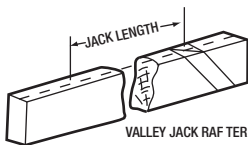
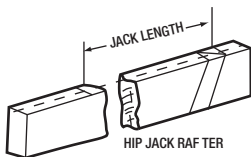

Using DEWALT RAFTER SQUARE (continued)

8) From the length marked, make a plumb cut line on the side of the rafter.

9) For a valley-jack, the rafter will be cut parallel to this line to fit against the ridge board. Be sure this plumb line on the valley-jack is in the same direction as the plumb line at the opposite end of the rafter, that is, parallel to it!

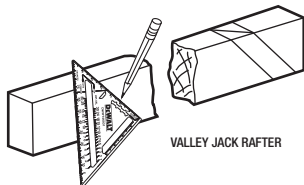

10) For a hip-jack, use a common rafter as a template, and mark the heel and seat cuts (birds-mouth), on the side of the rafter at the bottom plumb cut line. In case there isn't a common rafter available, lay out the heel and seat cut lines as described on page 30 under Seat Cuts.

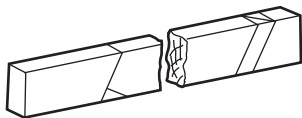

11) Again on a hip-jack, the additional length for the eave is laid out the same as it was for the common rafter. A common rafter may be used as a template. if one is available!

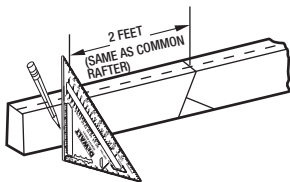

Using DEWALT RAFTER SQUARE (continued)

12) Compensation must now be made for the thickness of the hip or valley rafter in the length of the jack rafter, just as was done for the hip and valley rafter to compensate for the thickness of the ridge board. Mark another plumb cut line $1\frac{1}{16}$ inch from and parallel to the original plumb cut mark made in Step 1) above. (The $1\frac{1}{16}$ inch dimension being half the diagonal thickness of the hip or valley rafter).s

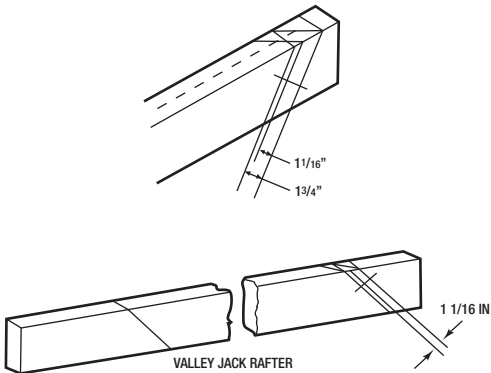

13) From the top of this plumb line, mark a line across the top of the rafter parallel to the side cut mark made in Step No. 6). These last side and plumb cut marks are the marks on which the rafter will be cut. Cutting along this plumb cut line with a portable electric circular saw set at 45 degrees, will result in the correct side cut angle.

Using DeWALT RAFTER SQUARE (continued)

14) A valley-jack rafter must be further reduced in length to compensate for the thickness of the ridge board which it abuts. This is accomplished in the same manner in which the common rafter was shortened, and for the same reason. (Refer to Page 24-Palter Length).

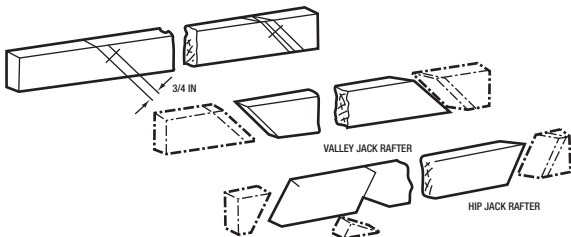

Scribing lines

To make rip cuts that follow the contours of your materials, the DeWALT Rafter Square includes scribing notches parallel to the rule edge, for easy and accurate marking between 1" and 2.5", and one at line marking tool guidance for depths.

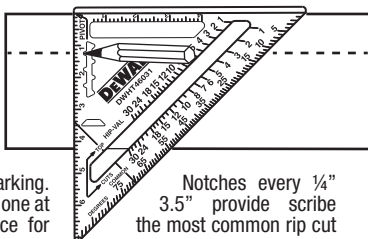

Notches every $\frac{1}{4}$ "
3.5" provide scribe
the most common rip cut
depths.

For example, if you want to remove 1.5" length or width of your material, uniform to the material's current contours, you will start by laying the DeWALT rafter square flat on the top of your material, with the wide base parallel to and hanging over the edge of the material you want to remove. Make sure the base is pushed against, and in full contact with the material edge you want to remove. Push your marking instrument into the 1.5" notch until it maintains sufficient contact with your material and is centered in the notch. Keeping the pressure against the base in order to maintain full contact with the material edge, slide the square along the edge of your material, marking the full length that needs to be cut. Check the scribe line with a tape rule to ensure sufficient consistency in guiding an accurate cut.

ADDITIONAL FEATURES AND USES

Protractor Scale

The DEWALT **Rafter Square** is embossed with a scale, graduated in degrees which makes it very handy for use as protractor. The scale is embossed on both sides of the square body so that either side may be used. The illustration below shows the angles which may be obtained by aligning the pivot and the 30 and 60 degree graduation with the edge.

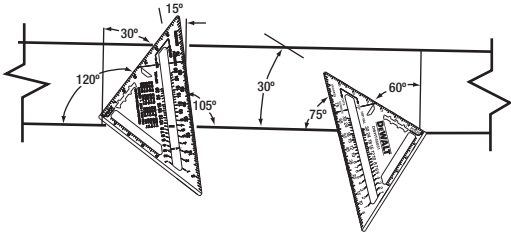

Used in conjunction with a level, the **Rafter Square** may be used to determine angles of construction members, the rise of existing roofs and rafters, or to adjust a member to any desired angle, as illustrated below.

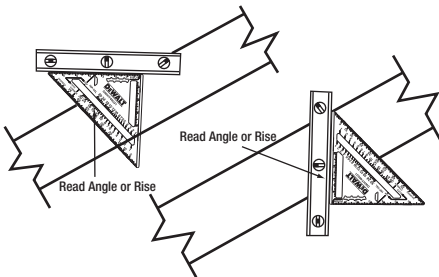

**TABLE 1
TABLES OF RAFTER LENGTHS**

RISE IN INCHES PER FOOT OF RUN	BUILDING WIDTH			
	3 FEET		4 FEET	
	COMMON FEET-INCHES	HIP-VAL FEET-INCHES	COMMON FEET-INCHES	HIP-VAL FEET-INCHES
1	1-6 ¹ / ₁₆	2-1 ¹ / ₂	2-0 ¹ / ₁₆	2-10
2	1-6 ¹ / ₄	2-1 ⁵ / ₈	2-0 ⁵ / ₁₆	2-10 ³ / ₁₆
3	1-6 ⁹ / ₁₆	2-1 ⁷ / ₈	2-0 ³ / ₄	2-10 ⁷ / ₁₆
4	1-7	2-2 ¹ / ₈	2-1 ⁵ / ₁₆	2-10 ⁷ / ₈
5	1-7 ¹ / ₂	2-2 ⁹ / ₁₆	2-2	3-11 ³ / ₈
6	1-8 ¹ / ₈	2-3	2-2 ¹³ / ₁₆	3-0
7	1-8 ¹³ / ₁₆	2-3 ⁹ / ₁₆	2-3 ¹³ / ₁₆	3-0 ¹¹ / ₁₆
8	1-9 ⁵ / ₈	2-4 ¹ / ₈	2-4 ⁷ / ₈	3-1 ¹ / ₂
9	1-10 ¹ / ₂	2-4 ¹³ / ₁₆	2-6	3-2 ⁷ / ₁₆
10	1-11 ⁷ / ₁₆	2-5 ⁹ / ₁₆	2-7 ¹ / ₄	3-3 ³ / ₈
11	2-0 ⁷ / ₁₆	2-6 ⁵ / ₁₆	2-8 ⁹ / ₁₆	3-4 ⁷ / ₁₆
12	2-1 ⁷ / ₁₆	2-7 ³ / ₁₆	2-9 ¹⁵ / ₁₆	3-5 ⁹ / ₁₆
	5 FEET		6 FEET	
1	2-6 ¹ / ₈	3-6 ¹ / ₂	3-0 ¹ / ₈	4-3
2	2-6 ⁷ / ₁₆	3-6 ³ / ₄	3-0 ¹ / ₂	4-3 ¹ / ₄
3	2-6 ¹⁵ / ₁₆	3-7 ¹ / ₁₆	3-1 ¹ / ₈	4-3 ¹¹ / ₁₆
4	2-7 ⁵ / ₈	3-7 ⁹ / ₁₆	3-1 ¹⁵ / ₁₆	4-4 ⁵ / ₁₆
5	2-8 ¹ / ₂	3-8 ¹ / ₄	3-3	4-5 ¹ / ₁₆
6	2-9 ⁹ / ₁₆	3-9	3-4 ¹ / ₄	4-6
7	2-10 ³ / ₄	3-9 ⁷ / ₈	3-5 ¹¹ / ₁₆	4-7 ¹ / ₁₆
8	3-0 ¹ / ₁₆	3-10 ⁷ / ₈	3-7 ¹ / ₄	4-8 ⁵ / ₁₆
9	3-1 ¹ / ₂	4-0	3-9	4-9 ⁵ / ₈
10	3-3 ¹ / ₁₆	4-1 ¹ / ₄	3-10 ⁷ / ₈	4-11 ¹ / ₁₆
11	3-4 ¹¹ / ₁₆	4-2 ⁹ / ₁₆	4-0 ¹³ / ₁₆	5-0 ¹¹ / ₁₆
12	3-6 ⁷ / ₁₆	4-3 ¹⁵ / ₁₆	4-2 ¹⁵ / ₁₆	5-2 ⁵ / ₁₆

**TABLE 1
TABLES OF RAFTER LENGTHS**

RISE IN INCHES PER FOOT OF RUN	BUILDING WIDTH			
	7 FEET		8 FEET	
	COMMON FEET-INCHES	HIP-VAL FEET-INCHES	COMMON FEET-INCHES	HIP-VAL FEET-INCHES
1	3-6 ¹ / ₈	4-11 ¹ / ₂	4-0 ³ / ₁₆	5-8
2	3-6 ⁹ / ₁₆	4-11 ³ / ₁₆	4-0 ¹¹ / ₁₆	5-8 ³ / ₈
3	3-7 ⁵ / ₁₆	5-0 ⁵ / ₁₆	4-1 ¹ / ₂	5-8 ¹⁵ / ₁₆
4	3-8 ¹ / ₄	5-1 ¹ / ₁₆	4-2 ⁵ / ₈	5-9 ³ / ₄
5	3-9 ¹ / ₂	5-1 ¹⁵ / ₁₆	4-4	5-10 ³ / ₄
6	3-10 ¹⁵ / ₁₆	5-3	4-5 ¹¹ / ₁₆	6-0
7	4-0 ⁵ / ₈	5-4 ¹ / ₄	4-7 ⁹ / ₁₆	6-1 ⁷ / ₁₆
8	4-2 ¹ / ₂	5-5 ¹¹ / ₁₆	4-9 ¹¹ / ₁₆	6-3 ¹ / ₁₆
9	4-4 ¹ / ₂	5-7 ¹ / ₄	5-0	6-4 ¹³ / ₁₆
10	4-6 ¹¹ / ₁₆	5-8 ¹⁵ / ₁₆	5-2 ¹ / ₂	6-6 ¹³ / ₁₆
11	4-9	5-10 ³ / ₄	5-5 ¹ / ₈	6-8 ⁷ / ₈
12	4-11 ³ / ₈	6-0 ³ / ₄	5-7 ⁷ / ₈	6-11 ¹ / ₈
	9 FEET		10 FEET	
1	4-6 ³ / ₁₆	6-4 ¹ / ₂	5-0 ³ / ₁₆	7-1
2	4-6 ³ / ₄	6-4 ⁷ / ₈	5-0 ¹³ / ₁₆	7-1 ⁷ / ₁₆
3	4-7 ¹¹ / ₁₆	6-5 ⁹ / ₁₆	5-1 ⁷ / ₈	7-2 ¹ / ₈
4	4-8 ¹¹ / ₁₆	6-6 ¹ / ₂	5-3 ¹ / ₄	7-3 ³ / ₁₆
5	4-10 ¹ / ₂	6-7 ⁵ / ₈	5-5	7-4 ⁷ / ₁₆
6	5-0 ³ / ₈	6-9	5-7 ¹ / ₁₆	7-6
7	5-2 ¹ / ₂	6-10 ⁵ / ₈	5-9 ⁷ / ₁₆	7-7 ¹³ / ₁₆
8	5-4 ⁷ / ₈	7-0 ⁷ / ₁₆	6-0 ¹ / ₈	7-9 ¹³ / ₁₆
9	5-7 ¹ / ₂	7-2 ⁷ / ₁₆	6-3	8-0 ¹ / ₁₆
10	5-10 ⁵ / ₁₆	7-4 ⁵ / ₈	6-6 ¹ / ₈	8-2 ¹ / ₂
11	6-1 ¹ / ₄	7-7	6-9 ³ / ₈	8-5 ¹ / ₈
12	6-4 ³ / ₈	7-9 ¹ / ₂	7-0 ⁷ / ₈	8-7 ¹⁵ / ₁₆

**TABLE 1
TABLES OF RAFTER LENGTHS**

RISE IN INCHES PER FOOT OF RUN	BUILDING WIDTH			
	11 FEET		12 FEET	
	COMMON FEET-INCHES	HIP-VAL FEET-INCHES	COMMON FEET-INCHES	HIP-VAL FEET-INCHES
1	5-6 ¹ / ₄	7-9 ¹ / ₂	6-0 ¹ / ₄	8-6
2	5-6 ¹⁵ / ₁₆	7-10	6-1	8-6 ¹ / ₂
3	5-8	7-10 ¹³ / ₁₆	6-2 ³ / ₁₆	8-7 ³ / ₈
4	5-9 ⁹ / ₁₆	7-11 ⁷ / ₈	6-3 ⁷ / ₈	8-8 ⁵ / ₈
5	5-11 ¹ / ₂	8-1 ⁵ / ₁₆	6-6	8-10 ¹ / ₈
6	4-1 ¹³ / ₁₆	8-3	6-8 ¹ / ₂	9-0
7	6-4 ⁷ / ₁₆	8-4 ¹⁵ / ₁₆	6-11 ³ / ₈	9-2 ¹ / ₈
8	6-7 ⁵ / ₁₆	8-7 ³ / ₁₆	7-2 ⁹ / ₁₆	9-4 ⁹ / ₁₆
9	6-10 ¹ / ₂	8-9 ⁵ / ₈	7-6	9-7 ¹ / ₄
10	7-1 ¹⁵ / ₁₆	9-0 ⁵ / ₁₆	7-9 ³ / ₄	9-10 ³ / ₁₆
11	7-5 ⁹ / ₁₆	9-3 ¹ / ₄	8-1 ¹¹ / ₁₆	10-1 ⁵ / ₁₆
12	7-9 ⁵ / ₁₆	9-6 ⁵ / ₁₆	8-5 ¹³ / ₁₆	10-4 ¹¹ / ₁₆
	13 FEET		14 FEET	
1	6-6 ¹ / ₄	9-2 ¹ / ₂	7-0 ⁵ / ₁₆	9-11
2	6-7 ¹ / ₁₆	9-3 ¹ / ₁₆	7-1 ³ / ₁₆	9-11 ⁵ / ₈
3	6-8 ³ / ₈	9-4	7-2 ⁹ / ₁₆	10-0 ⁵ / ₈
4	6-10 ¹ / ₄	9-5 ⁵ / ₁₆	7-4 ⁹ / ₁₆	10-2 ¹ / ₁₆
5	7-0 ¹ / ₂	9-7	7-7	10-3 ¹³ / ₁₆
6	7-3 ³ / ₁₆	9-9	7-9 ¹⁵ / ₁₆	10-6
7	7-6 ⁵ / ₁₆	9-11 ⁵ / ₁₆	8-1 ¹ / ₄	10-8 ¹ / ₂
8	7-9 ³ / ₄	10-1 ¹⁵ / ₁₆	8-4 ¹⁵ / ₁₆	10-11 ⁵ / ₁₆
9	8-1 ¹ / ₂	10-4 ⁷ / ₈	8-9	11-2 ⁷ / ₁₆
10	8-5 ⁹ / ₁₆	10-8 ¹ / ₁₆	9-1 ⁵ / ₁₆	11-5 ⁷ / ₈
11	8-9 ¹³ / ₁₆	10-11 ⁷ / ₁₆	9-5 ¹⁵ / ₁₆	11-9 ⁹ / ₁₆
12	9-2 ¹ / ₁₆	11-3 ¹ / ₈	9-10 ¹³ / ₁₆	12-1 ¹ / ₂

**TABLE 1
TABLES OF RAFTER LENGTHS**

RISE IN INCHES PER FOOT OF RUN	BUILDING WIDTH			
	15 FEET		16 FEET	
	COMMON FEET-INCHES	HIP-VAL FEET-INCHES	COMMON FEET-INCHES	HIP-VAL FEET-INCHES
1	7-6 ⁵ / ₁₆	10-7 ¹ / ₂	8-0 ⁵ / ₁₆	11-4
2	7-7 ¹ / ₄	10-8 ³ / ₁₆	8-1 ⁵ / ₁₆	11-4 ¹¹ / ₁₆
3	7-8 ³ / ₄	10-9 ¹ / ₄	8-2 ¹⁵ / ₁₆	11-5 ⁷ / ₈
4	7-10 ⁷ / ₈	10-10 ³ / ₄	8-5 ³ / ₁₆	11-7 ¹ / ₂
5	8-1 ¹ / ₂	11-0 ¹¹ / ₁₆	8-8	11-9 ⁹ / ₁₆
6	8-4 ⁵ / ₈	11-3	8-11 ⁵ / ₁₆	12-0
7	8-8 ³ / ₁₆	11-5 ¹¹ / ₁₆	9-3 ¹ / ₈	12-2 ⁷ / ₈
8	9-0 ³ / ₁₆	11-8 ¹¹ / ₁₆	9-7 ³ / ₈	12-6 ¹ / ₁₆
9	9-4 ¹ / ₂	12-0 ¹ / ₁₆	10-0	12-9 ¹¹ / ₁₆
10	9-9 ¹ / ₈	12-3 ³ / ₄	10-4 ¹⁵ / ₁₆	13-1 ⁹ / ₁₆
11	10-2 ¹ / ₁₆	12-7 ¹¹ / ₁₆	10-10 ¹ / ₄	13-5 ¹³ / ₁₆
12	10-7 ¹ / ₄	12-11 ⁷ / ₈	11-3 ³ / ₄	13-10 ¹ / ₄
	17 FEET		18 FEET	
1	8-6 ³ / ₈	12-0 ¹ / ₂	9-0 ³ / ₈	12-9
2	8-7 ⁷ / ₁₆	12-1 ¹ / ₄	9-1 ¹ / ₂	12-9 ¹³ / ₁₆
3	8-9 ¹ / ₈	12-2 ¹ / ₂	9-3 ⁵ / ₁₆	12-11 ¹ / ₈
4	8-11 ¹ / ₂	12-4 ³ / ₁₆	9-5 ¹³ / ₁₆	13-0 ¹⁵ / ₁₆
5	9-2 ¹ / ₂	12-6 ³ / ₈	9-9	13-3 ¹ / ₄
6	9-6 ¹ / ₁₆	12-9	10-0 ³ / ₄	13-6
7	9-10 ¹ / ₁₆	13-0 ¹ / ₁₆	10-5 ¹ / ₁₆	13-9 ³ / ₁₆
8	10-2 ⁹ / ₁₆	13-3 ¹ / ₂	10-9 ¹³ / ₁₆	14-0 ⁷ / ₈
9	10-7 ¹ / ₂	13-7 ¹ / ₄	11-3	14-4 ⁷ / ₈
10	11-0 ³ / ₄	13-1 ⁷ / ₁₆	11-8 ⁹ / ₁₆	14-9 ¹ / ₄
11	11-6 ³ / ₈	14-3 ⁷ / ₈	12-2 ¹ / ₂	15-2
12	12-0 ¹ / ₄	14-8 ¹¹ / ₁₆	12-8 ³ / ₄	15-7 ¹ / ₁₆

TABLE 1
TABLES OF RAFTER LENGTHS

RISE IN INCHES PER FOOT OF RUN	BUILDING WIDTH			
	19 FEET		20 FEET	
	COMMON FEET-INCHES	HIP-VAL FEET-INCHES	COMMON FEET-INCHES	HIP-VAL FEET-INCHES
1	9-6 ³ / ₈	13-5 ¹ / ₂	10-0 ⁷ / ₁₆	14-2
2	9-7 ⁹ / ₁₆	13-6 ⁵ / ₁₆	10-1 ⁵ / ₈	14-2 ⁷ / ₈
3	9-9 ¹ / ₂	13-7 ³ / ₄	10-3 ¹¹ / ₁₆	14-4 ⁵ / ₁₆
4	10-0 ³ / ₁₆	13-9 ⁵ / ₈	10-6 ¹ / ₂	14-6 ³ / ₈
5	10-3 ¹ / ₂	14-0 ¹ / ₁₆	10-10	14-8 ¹⁵ / ₁₆
6	10-7 ⁷ / ₁₆	14-3	11-2 ³ / ₁₆	15-0
7	11-0	14-6 ³ / ₈	11-6 ¹⁵ / ₁₆	15-3 ⁹ / ₁₆
8	11-5	14-10 ¹ / ₄	12-0 ¹ / ₄	15-7 ⁵ / ₈
9	11-10 ¹ / ₂	15-2 ¹ / ₂	12-6	16-0 ¹ / ₈
10	12-4 ³ / ₈	15-7 ¹ / ₁₆	13-0 ³ / ₁₆	16-5
11	12-10 ⁵ / ₈	16-0 ¹ / ₁₆	13-6 ¹³ / ₁₆	16-10 ¹ / ₄
12	13-5 ¹ / ₄	16-5 ⁷ / ₁₆	14-1 ¹¹ / ₁₆	17-3 ⁷ / ₈
	21 FEET		22 FEET	
1	10-6 ⁷ / ₁₆	14-10 ¹ / ₂	11-0 ⁷ / ₁₆	15-7
2	10-7 ³ / ₄	14-11 ⁷ / ₁₆	11-1 ¹³ / ₁₆	15-7 ¹⁵ / ₁₆
3	10-9 ⁷ / ₈	15-0 ¹⁵ / ₁₆	11-4 ¹ / ₁₆	15-9 ⁹ / ₁₆
4	11-0 ¹³ / ₁₆	15-3 ¹ / ₁₆	11-7 ¹ / ₈	15-11 ¹³ / ₁₆
5	11-4 ¹ / ₂	15-5 ³ / ₄	11-11	16-2 ⁵ / ₈
6	11-8 ⁷ / ₈	15-9	12-3 ⁹ / ₁₆	16-6
7	12-1 ⁷ / ₈	16-0 ³ / ₄	12-8 ¹³ / ₁₆	16-9 ¹⁵ / ₁₆
8	12-7 ⁷ / ₁₆	16-5	13-2 ⁵ / ₈	17-2 ³ / ₈
9	13-1 ¹ / ₂	16-9 ¹¹ / ₁₆	13-9	17-7 ⁵ / ₁₆
10	13-8	17-2 ¹³ / ₁₆	14-3 ¹³ / ₁₆	18-0 ¹¹ / ₁₆
11	14-2 ¹⁵ / ₁₆	17-8 ³ / ₈	14-11 ¹ / ₁₆	18-6 ⁷ / ₁₆
12	14-10 ³ / ₁₆	18-2 ¹ / ₄	15-6 ¹¹ / ₁₆	19-0 ⁵ / ₈

**TABLE 1
TABLES OF RAFTER LENGTHS**

RISE IN INCHES PER FOOT OF RUN	BUILDING WIDTH			
	23 FEET		24 FEET	
	COMMON FEET-INCHES	HIP-VAL FEET-INCHES	COMMON FEET-INCHES	HIP-VAL FEET-INCHES
1	11-6 ¹ / ₂	16-3 ¹ / ₂	12-0 ¹ / ₂	17-0
2	11-7 ⁷ / ₈	16-4 ¹ / ₂	12-2	17-1 ¹ / ₁₆
3	11-10 ¹ / ₄	16-6 ³ / ₁₆	12-4 ⁷ / ₁₆	17-2 ¹³ / ₁₆
4	12-1 ⁷ / ₁₆	16-8 ¹ / ₂	12-7 ¹³ / ₁₆	17-5 ¹ / ₄
5	12-5 ¹ / ₂	16-11 ⁷ / ₁₆	13-0	17-8 ⁵ / ₁₆
6	12-10 ⁵ / ₁₆	17-3	13-5	18-0
7	13-3 ³ / ₄	17-7 ¹ / ₈	13-10 ¹¹ / ₁₆	18-4 ⁵ / ₁₆
8	13-9 ⁷ / ₈	17-11 ³ / ₄	14-5 ¹ / ₁₆	18-9 ¹ / ₈
9	14-4 ¹ / ₂	18-4 ¹⁵ / ₁₆	15-0	19-2 ¹ / ₂
10	14-1 ⁵ / ₈	18-10 ¹ / ₂	15-7 ⁷ / ₁₆	19-8 ³ / ₈
11	15-7 ³ / ₁₆	19-4 ⁹ / ₁₆	16-3 ³ / ₈	20-2 ¹¹ / ₁₆
12	16-3 ³ / ₁₆	19-11	16-11 ⁵ / ₈	20-9 ⁷ / ₁₆
	25 FEET		26 FEET	
1	12-6 ¹ / ₂	17-8 ¹ / ₂	13-0 ⁹ / ₁₆	18-5
2	12-8 ¹ / ₁₆	17-9 ⁵ / ₈	13-2 ¹ / ₈	18-6 ¹ / ₈
3	12-10 ⁵ / ₈	17-11 ⁷ / ₁₆	13-4 ¹³ / ₁₆	18-8 ¹ / ₁₆
4	13-2 ¹ / ₈	18-1 ¹⁵ / ₁₆	13-8 ⁷ / ₁₆	18-10 ¹¹ / ₁₆
5	13-6 ¹ / ₂	18-5 ¹ / ₈	14-1	19-2
6	13-11 ¹¹ / ₁₆	18-9	14-6 ⁷ / ₁₆	19-6
7	14-5 ⁵ / ₈	19-1 ¹ / ₂	15-0 ⁵ / ₈	19-10 ⁵ / ₈
8	15-0 ¹ / ₄	19-6 ¹ / ₂	15-7 ¹ / ₂	20-3 ⁷ / ₈
9	15-7 ¹ / ₂	20-0 ¹ / ₈	16-3	20-9 ³ / ₄
10	16-3 ¹ / ₄	20-6 ¹ / ₄	16-11 ¹ / ₁₆	21-4 ¹ / ₁₆
11	16-11 ¹ / ₂	21-0 ¹³ / ₁₆	17-7 ⁵ / ₈	21-10 ¹⁵ / ₁₆
12	17-8 ¹ / ₈	21-7 ¹³ / ₁₆	18-4 ⁵ / ₈	22-6 ³ / ₁₆

TABLE 1
TABLES OF RAFTER LENGTHS

RISE IN INCHES PER FOOT OF RUN	BUILDING WIDTH			
	27 FEET		28 FEET	
	COMMON FEET-INCHES	HIP-VAL FEET-INCHES	COMMON FEET-INCHES	HIP-VAL FEET-INCHES
1	13-6 ⁹ / ₁₆	19-1 ¹ / ₂	14-0 ⁹ / ₁₆	19-10
2	13-8 ¹ / ₄	19-2 ¹¹ / ₁₆	14-2 ⁵ / ₁₆	19-11 ¹ / ₄
3	13-11	19-4 ⁵ / ₈	14-5 ³ / ₁₆	20-1 ¹ / ₄
4	14-2 ³ / ₄	19-7 ³ / ₈	14-9 ¹ / ₁₆	20-4 ¹ / ₈
5	14-7 ¹ / ₂	19-10 ¹³ / ₁₆	15-2	20-7 ¹¹ / ₁₆
6	15-1 ¹ / ₈	20-3	15-7 ¹³ / ₁₆	21-0
7	15-7 ⁹ / ₁₆	20-7 ¹³ / ₁₆	16-2 ¹ / ₂	21-5
8	16-2 ¹¹ / ₁₆	21-1 ⁵ / ₁₆	16-9 ¹⁵ / ₁₆	21-10 ¹¹ / ₁₆
9	16-10 ¹ / ₂	21-7 ⁵ / ₁₆	17-6	22-4 ¹⁵ / ₁₆
10	17-6 ⁷ / ₈	22-1 ¹⁵ / ₁₆	18-2 ¹¹ / ₁₆	22-11 ³ / ₄
11	18-3 ³ / ₄	22-9	18-11 ⁷ / ₈	23-7 ¹ / ₈
12	19-1 ¹ / ₈	23-4 ⁹ / ₁₆	19-9 ⁹ / ₁₆	24-3
	29 FEET		30 FEET	
1	14-6 ⁵ / ₈	20-6 ¹ / ₂	15-0 ⁵ / ₈	21-3
2	14-8 ³ / ₈	20-7 ³ / ₄	15-2 ¹ / ₂	21-4 ⁵ / ₁₆
3	14-11 ³ / ₈	20-9 ⁷ / ₈	15-5 ⁹ / ₁₆	21-6 ¹ / ₂
4	15-3 ⁷ / ₁₆	21-0 ¹³ / ₁₆	15-9 ³ / ₄	21-9 ⁹ / ₁₆
5	15-8 ¹ / ₂	21-4 ⁹ / ₁₆	16-3	22-1 ³ / ₈
6	16-2 ⁹ / ₁₆	21-9	16-9 ¹ / ₄	22-6
7	16-9 ⁷ / ₁₆	22-2 ³ / ₁₆	17-4 ³ / ₈	22-11 ³ / ₈
8	17-5 ¹ / ₈	22-8 ¹ / ₁₆	18-0 ⁵ / ₁₆	23-5 ⁷ / ₁₆
9	18-1 ¹ / ₂	23-2 ⁹ / ₁₆	18-9	24-0 ¹ / ₈
10	18-10 ¹ / ₂	23-9 ⁵ / ₈	19-6 ⁵ / ₁₆	24-7 ⁷ / ₁₆
11	19-8 ¹ / ₁₆	24-5 ¹ / ₄	20-4 ³ / ₁₆	25-3 ³ / ₈
12	20-6 ¹ / ₁₆	25-1 ³ / ₈	21-2 ⁹ / ₁₆	25-11 ³ / ₄

**TABLE 1
TABLES OF RAFTER LENGTHS**

RISE IN INCHES PER FOOT OF RUN	BUILDING WIDTH			
	31 FEET		32 FEET	
	COMMON FEET-INCHES	HIP-VAL FEET-INCHES	COMMON FEET-INCHES	HIP-VAL FEET-INCHES
1	15-6 ⁵ / ₈	21-11 ¹ / ₂	16-0 ¹¹ / ₁₆	22-8
2	15-8 ⁹ / ₁₆	22-0 ⁷ / ₈	16-2 ⁵ / ₈	22-9 ⁷ / ₁₆
3	15-1 ³ / ₄	22-3 ¹ / ₈	16-5 ¹⁵ / ₁₆	22-11 ³ / ₄
4	16-4 ¹ / ₁₆	22-6 ¹ / ₄	16-10 ³ / ₈	23-3
5	16-9 ¹ / ₂	22-10 ¹ / ₄	17-4	23-7 ¹ / ₁₆
6	17-3 ¹⁵ / ₁₆	23-3	17-10 ¹¹ / ₁₆	24-0
7	17-11 ⁵ / ₁₆	23-8 ⁹ / ₁₆	18-6 ¹ / ₄	24-5 ³ / ₄
8	18-7 ⁹ / ₁₆	24-2 ¹³ / ₁₆	19-2 ³ / ₄	25-0 ³ / ₁₆
9	19-4 ¹ / ₂	24-9 ³ / ₄	20-0	25-7 ³ / ₈
10	20-2 ¹ / ₈	25-5 ⁷ / ₁₆	20-9 ¹⁵ / ₁₆	26-3 ³ / ₁₆
11	21-0 ⁵ / ₁₆	26-1 ¹ / ₁₆	21-8 ⁷ / ₁₆	26-11 ⁹ / ₁₆
12	21-1 ¹ / ₁₆	26-10 ³ / ₁₆	22-7 ¹ / ₂	27-8 ⁹ / ₁₆
	33 FEET		34 FEET	
1	16-6 ¹¹ / ₁₆	23-4 ¹ / ₂	17-0 ¹¹ / ₁₆	24-1
2	16-8 ³ / ₄	23-5 ¹⁵ / ₁₆	17-2 ¹³ / ₁₆	24-2 ¹ / ₂
3	17-0 ¹ / ₁₆	23-8 ³ / ₈	17-6 ¹ / ₄	24-5
4	17-4 ¹¹ / ₁₆	23-11 ¹¹ / ₁₆	17-11 ¹ / ₁₆	24-8 ³ / ₈
5	17-10 ¹ / ₂	24-3 ¹⁵ / ₁₆	18-5	25-0 ³ / ₄
6	18-5 ³ / ₈	24-9	19-0 ¹ / ₁₆	25-6
7	19-1 ¹ / ₄	25-2 ⁷ / ₈	19-8 ³ / ₁₆	26-0 ¹ / ₁₆
8	19-9 ¹⁵ / ₁₆	25-9 ⁹ / ₁₆	20-5 ³ / ₁₆	26-6 ¹⁵ / ₁₆
9	20-7 ¹ / ₂	26-4 ¹⁵ / ₁₆	21-3	27-2 ⁹ / ₁₆
10	21-5 ³ / ₄	27-1	22-1 ⁹ / ₁₆	27-10 ⁷ / ₈
11	22-4 ⁵ / ₈	27-4 ¹¹ / ₁₆	23-0 ³ / ₄	28-7 ¹³ / ₁₆
12	23-4	28-6 ¹⁵ / ₁₆	24-0 ¹ / ₂	29-5 ⁵ / ₁₆

TABLE 1
TABLES OF RAFTER LENGTHS

RISE IN INCHES PER FOOT OF RUN	BUILDING WIDTH			
	35 FEET		36 FEET	
	COMMON FEET-INCHES	HIP-VAL FEET-INCHES	COMMON FEET-INCHES	HIP-VAL FEET-INCHES
1	17-6 ³ / ₄	24-9 ¹ / ₂	18-0 ³ / ₄	25-6
2	17-8 ⁷ / ₈	24-11 ¹ / ₁₆	18-3	25-7 ⁹ / ₁₆
3	18-0 ⁷ / ₁₆	25-1 ⁹ / ₁₆	18-6 ⁵ / ₈	25-10 ³ / ₁₆
4	18-5 ³ / ₈	25-5 ¹ / ₈	18-11 ¹¹ / ₁₆	26-1 ¹³ / ₁₆
5	18-11 ¹ / ₂	25-9 ⁵ / ₈	19-6	26-6 ⁷ / ₁₆
6	19-6 ¹³ / ₁₆	26-3	20-1 ¹ / ₂	27-0
7	20-3 ¹ / ₈	26-9 ¹ / ₄	20-10 ¹ / ₆	27-6 ⁷ / ₁₆
8	21-0 ³ / ₈	27-4 ⁵ / ₁₆	21-7 ⁵ / ₈	28-1 ¹¹ / ₁₆
9	21-10 ¹ / ₂	28-0 ³ / ₁₆	22-6	28-9 ³ / ₄
10	22-9 ³ / ₈	28-8 ¹¹ / ₁₆	23-5 ³ / ₁₆	29-6 ⁹ / ₁₆
11	23-8 ⁷ / ₈	29-5 ¹⁵ / ₁₆	24-5	30-4
12	24-9	30-3 ³ / ₄	25-5 ¹ / ₂	31-2 ¹ / ₈
	37 FEET		38 FEET	
1	18-6 ³ / ₄	26-2 ¹ / ₂	19-0 ¹³ / ₁₆	26-11
2	18-9 ¹ / ₁₆	26-4 ¹ / ₈	19-3 ¹ / ₈	27-0 ¹¹ / ₁₆
3	19-0 ¹³ / ₁₆	26-6 ¹³ / ₁₆	19-7	27-3 ⁷ / ₁₆
4	19-6	26-10 ⁹ / ₁₆	20-0 ⁵ / ₁₆	27-7 ¹ / ₄
5	20-0 ¹ / ₂	27-3 ⁵ / ₁₆	20-7	28-0 ¹ / ₈
6	20-8 ³ / ₁₆	27-9	21-2 ¹⁵ / ₁₆	28-6
7	21-5	28-3 ⁵ / ₈	21-11 ¹⁵ / ₁₆	29-0 ¹³ / ₁₆
8	22-2 ¹³ / ₁₆	28-11 ¹ / ₁₆	22-10	29-8 ¹ / ₂
9	23-1 ¹ / ₂	29-7 ³ / ₈	23-9	30-5
10	24-1	30-4 ⁷ / ₁₆	24-8 ¹³ / ₁₆	31-2 ¹ / ₄
11	25-1 ³ / ₁₆	31-2 ¹ / ₈	25-9 ⁵ / ₁₆	32-0 ¹ / ₄
12	26-1 ¹⁵ / ₁₆	32-0 ¹ / ₂	26-10 ⁷ / ₁₆	32-10 ¹⁵ / ₁₆

**TABLE 1
TABLES OF RAFTER LENGTHS**

RISE IN INCHES PER FOOT OF RUN	BUILDING WIDTH			
	39 FEET		40 FEET	
	COMMON FEET-INCHES	HIP-VAL FEET-INCHES	COMMON FEET-INCHES	HIP-VAL FEET-INCHES
1	19-6 ¹³ / ₁₆	27-7 ¹ / ₂	20-0 ¹³ / ₁₆	28-4
2	19-9 ¹ / ₄	27-9 ³ / ₁₆	20-3 ⁵ / ₁₆	28-5 ³ / ₄
3	20-1 ³ / ₁₆	28-0 ¹ / ₁₆	20-7 ³ / ₈	28-8 ¹¹ / ₁₆
4	20-6 ¹¹ / ₁₆	28-4	21-1	29-0 ¹¹ / ₁₆
5	21-1 ¹ / ₂	28-9	21-8	29-5 ¹³ / ₁₆
6	21-9 ⁵ / ₈	29-3	22-4 ⁵ / ₁₆	30-0
7	22-6 ⁷ / ₈	29-10	23-1 ⁷ / ₈	30-7 ¹ / ₈
8	23-5 ¹ / ₄	30-5 ⁷ / ₈	24-0 ⁷ / ₁₆	31-3 ¹ / ₄
9	24-4 ¹ / ₂	31-2 ⁹ / ₁₆	25-0	32-0 ³ / ₁₆
10	25-4 ⁵ / ₈	32-0 ¹ / ₈	26-0 ⁷ / ₁₆	32-9 ¹⁵ / ₁₆
11	26-5 ⁷ / ₁₆	32-10 ³ / ₈	27-1 ⁹ / ₁₆	33-8 ¹ / ₂
12	27-6 ¹⁵ / ₁₆	33-9 ⁵ / ₁₆	28-3 ⁷ / ₁₆	34-7 ¹¹ / ₁₆
	41 FEET		42 FEET	
1	20-6 ⁷ / ₈	29-0 ¹ / ₂	21-0 ⁷ / ₈	29-9
2	20-9 ³ / ₈	29-2 ⁵ / ₁₆	21-3 ¹ / ₂	29-10 ⁷ / ₈
3	21-1 ⁹ / ₁₆	29-5 ⁵ / ₁₆	21-7 ³ / ₄	30-1 ¹⁵ / ₁₆
4	21-7 ⁵ / ₁₆	29-9 ⁷ / ₁₆	22-1 ⁵ / ₈	30-6 ¹ / ₈
5	22-2 ¹ / ₂	30-2 ¹¹ / ₁₆	22-9	30-11 ¹ / ₂
6	22-11 ¹¹ / ₁₆	30-9	23-5 ³ / ₄	31-6
7	23-8 ¹³ / ₁₆	31-4 ⁵ / ₁₆	24-3 ³ / ₄	32-1 ¹ / ₂
8	24-7 ⁵ / ₈	32-0 ⁵ / ₈	25-2 ⁷ / ₈	32-10
9	25-7 ¹ / ₂	32-9 ¹³ / ₁₆	26-3	33-7 ³ / ₈
10	26-8 ¹ / ₄	33-7 ¹³ / ₁₆	27-4	34-5 ⁵ / ₈
11	27-9 ¹¹ / ₁₆	34-6 ⁹ / ₁₆	28-5 ⁷ / ₈	35-4 ¹¹ / ₁₆
12	28-11 ⁷ / ₈	35-6 ¹ / ₁₆	29-8 ³ / ₈	36-4 ¹ / ₂

**TABLE 1
TABLES OF RAFTER LENGTHS**

RISE IN INCHES PER FOOT OF RUN	BUILDING WIDTH			
	43 FEET		44 FEET	
	COMMON FEET-INCHES	HIP-VAL FEET-INCHES	COMMON FEET-INCHES	HIP-VAL FEET-INCHES
1	21-6 ⁷ / ₈	30-5 ¹ / ₂	22-0 ¹⁵ / ₁₆	31-2
2	21-9 ⁹ / ₁₆	30-7 ³ / ₈	22-3 ⁵ / ₈	31-3 ¹⁵ / ₁₆
3	22-1 ¹⁵ / ₁₆	30-10 ¹ / ₂	22-8 ¹ / ₈	31-7 ¹ / ₈
4	22-7 ¹⁵ / ₁₆	31-2 ⁷ / ₈	23-2 ¹ / ₄	31-11 ⁹ / ₁₆
5	23-3 ¹ / ₂	31-8 ³ / ₈	23-10	32-5 ¹ / ₄
6	24-0 ⁷ / ₁₆	32-3	24-7 ³ / ₁₆	33-0
7	24-10 ¹¹ / ₁₆	32-10 ¹¹ / ₁₆	25-5 ⁵ / ₈	33-7 ⁷ / ₈
8	25-10 ¹ / ₁₆	33-7 ³ / ₈	26-5 ⁵ / ₁₆	34-4 ³ / ₄
9	26-10 ¹ / ₂	34-5	27-6	35-2 ⁵ / ₈
10	27-11 ¹³ / ₁₆	35-3 ¹ / ₂	28-7 ⁵ / ₈	36-1 ³ / ₈
11	29-2	36-2 ¹³ / ₁₆	29-10 ¹ / ₈	37-0 ¹⁵ / ₁₆
12	30-4 ⁷ / ₈	37-2 ⁷ / ₈	31-1 ³ / ₈	38-1 ¹ / ₄
	45 FEET		46 FEET	
1	22-6 ¹⁵ / ₁₆	31-10 ¹ / ₂	23-0 ¹⁵ / ₁₆	32-7
2	22-9 ³ / ₄	32-0 ¹ / ₂	23-3 ¹³ / ₁₆	32-9
3	23-2 ⁵ / ₁₆	32-3 ³ / ₄	23-8 ¹ / ₂	33-0 ³ / ₈
4	23-8 ⁵ / ₈	32-8 ⁵ / ₁₆	24-2 ¹⁵ / ₁₆	33-5
5	24-4 ¹ / ₂	33-2 ¹ / ₁₆	24-11	33-10 ¹⁵ / ₁₆
6	25-1 ⁷ / ₈	33-9	25-8 ⁹ / ₁₆	34-6
7	26-0 ⁹ / ₁₆	34-5 ¹ / ₁₆	26-7 ¹ / ₂	35-2 ¹ / ₄
8	27-0 ¹ / ₂	35-2 ¹ / ₈	27-7 ¹¹ / ₁₆	35-11 ¹ / ₂
9	28-1 ¹ / ₂	36-0 ³ / ₁₆	28-9	36-9 ¹³ / ₁₆
10	29-3 ⁷ / ₁₆	36-11 ³ / ₁₆	29-11 ¹ / ₄	37-9 ¹ / ₁₆
11	30-6 ¹ / ₄	37-11 ¹ / ₁₆	31-2 ⁷ / ₁₆	38-9 ¹ / ₈
12	31-9 ¹³ / ₁₆	38-11 ⁵ / ₈	32-6 ⁵ / ₁₆	39-10 ¹ / ₁₆

TABLE 1
TABLES OF RAFTER LENGTHS

RISE IN INCHES PER FOOT OF RUN	BUILDING WIDTH			
	47 FEET		48 FEET	
	COMMON FEET-INCHES	HIP-VAL FEET-INCHES	COMMON FEET-INCHES	HIP-VAL FEET-INCHES
1	23-7	33-31/2	24-1	34-0
2	23-97/8	33-59/16	24-4	34-21/8
3	24-211/16	33-9	24-87/8	34-55/8
4	24-91/4	34-13/4	25-39/16	34-107/16
5	25-51/2	34-73/4	26-0	35-45/8
6	26-35/16	35-3	26-10	36-0
7	27-21/2	35-113/8	27-97/16	36-89/16
8	28-215/16	36-87/8	28-101/8	37-61/4
9	29-41/2	37-77/16	30-0	38-5
10	30-71/16	38-67/8	31-27/8	39-43/4
11	31-109/16	39-71/4	32-611/16	40-53/8
12	33-213/16	40-87/16	33-115/16	41-613/16
	49 FEET		50 FEET	
1	24-7	34-81/2	25-11/16	35-5
2	24-101/16	34-1011/16	25-41/8	35-73/16
3	25-31/16	35-21/4	25-91/4	35-1013/16
4	25-97/8	35-73/16	26-41/4	36-37/8
5	26-61/2	36-17/16	27-1	36-105/16
6	27-411/16	36-9	27-117/16	37-6
7	28-43/8	37-53/4	28-115/16	38-215/16
8	29-53/8	38-311/16	30-09/16	39-11/16
9	30-71/2	39-25/8	31-3	40-01/4
10	31-1011/16	41-25/8	32-61/2	41-07/16
11	33-213/16	41-31/2	33-11	42-15/8
12	34-73/4	42-51/4	35-41/4	43-35/8

TABLE 2
Difference in Length of Jack Rafters

FOR VARIOUS SPACING				
Rise	(FEET-INCHES)			
	16"	18"	20"	24"
1	1-4 ¹ / ₁₆	1-6 ¹ / ₁₆	1-8 ¹ / ₁₆	2-0 ¹ / ₁₆
2	1-4 ¹ / ₄	1-6 ¹ / ₄	1-8 ¹ / ₄	2-0 ⁵ / ₁₆
3	1-4 ¹ / ₂	1-6 ⁹ / ₁₆	1-8 ⁵ / ₈	2-0 ³ / ₄
4	1-4 ⁷ / ₈	1-7	1-9 ¹ / ₁₆	2-1 ⁵ / ₁₆
5	1-5 ⁵ / ₁₆	1-7 ¹ / ₂	1-9 ¹¹ / ₁₆	2-2
6	1-5 ⁷ / ₈	1-8 ¹ / ₈	1-10 ³ / ₈	2-2 ¹³ / ₁₆
7	1-6 ¹ / ₂	1-8 ¹³ / ₁₆	1-11 ¹ / ₈	2-3 ¹³ / ₁₆
8	1-7 ¹ / ₄	1-9 ⁵ / ₈	2-0 ¹ / ₁₆	2-4 ⁷ / ₈
9	1-8	1-10 ¹ / ₂	2-1	2-6
10	1-8 ¹³ / ₁₆	1-11 ⁷ / ₁₆	2-2 ¹ / ₁₆	2-7 ¹ / ₄
11	1-9 ¹¹ / ₁₆	2-0 ⁷ / ₁₆	2-3 ¹ / ₈	2-8 ⁹ / ₁₆
12	1-10 ⁵ / ₈	2-1 ⁷ / ₁₆	2-4 ⁵ / ₁₆	2-9 ¹⁵ / ₁₆
13	1-11 ⁹ / ₁₆	2-2 ⁹ / ₁₆	2-5 ¹ / ₂	2-11 ³ / ₈
14	2-0 ⁹ / ₁₆	2-3 ¹¹ / ₁₆	2-6 ³ / ₄	3-0 ⁷ / ₈
15	2-1 ⁵ / ₈	2-4 ¹³ / ₁₆	2-8	3-2 ⁷ / ₁₆
16	2-2 ¹¹ / ₁₆	2-6	2-9 ⁵ / ₁₆	3-4
17	2-3 ³ / ₄	2-7 ³ / ₁₆	2-10 ¹¹ / ₁₆	3-5 ⁵ / ₈
18	2-4 ⁷ / ₈	2-8 ⁷ / ₁₆	3-0 ¹ / ₁₆	3-7 ¹ / ₄
19	2-5 ¹⁵ / ₁₆	2-9 ¹¹ / ₁₆	3-1 ⁷ / ₁₆	3-8 ¹⁵ / ₁₆
20	2-7 ¹ / ₈	2-11	3-2 ⁷ / ₈	3-10 ⁵ / ₈
21	2-8 ¹ / ₄	3-0 ¹ / ₄	3-4 ⁵ / ₁₆	4-0 ³ / ₈
22	2-9 ⁷ / ₁₆	3-1 ⁹ / ₁₆	3-5 ³ / ₄	4-2 ¹ / ₈
23	2-10 ⁹ / ₁₆	3-2 ¹⁵ / ₁₆	3-7 ¹ / ₄	4-3 ⁷ / ₈
24	2-11 ³ / ₄	3-4 ¹ / ₄	4-8 ³ / ₄	4-5 ¹¹ / ₁₆

Rafter Lengths- For building widths in feet and inches:

The following tables are used to determine rafter lengths (common, hip and valley) for building widths which are in feet and fractions of a foot.

For example, to find the length of a common rafter for a 34 foot, 7 inch wide building with a roof rise of 8 inches per foot of run, find the length of a common rafter for a 34 foot wide building as 20 feet, $5^{3/16}$ inches from the previous tables. From the following table 3, find the additional length to add for 7 inch width and 8 inch rise as $4^{3/16}$ inches. Add this to the 20 feet, $5^{3/16}$ inches and obtain 20 feet, $9^{3/8}$ inches as the correct common rafter length.

To determine the lengths of hip and valley rafters, proceed as above using the appropriate preceding tables and table 4.

TABLE 3

ADDITIONAL LENGTH IN INCHES TO ADD TO COMMON RAFTERS						
Rise	For Inches Additional Building Width					
	1	2	3	4	5	6
1	1/2	1	1 1/2	2	2 9/16	3 1/16
2	1/2	1	1 1/2	2	2 9/16	3 1/16
3	1/2	1	1 9/16	2 1/16	2 9/16	3 1/16
4	1/2	1 1/16	1 9/16	2 1/8	2 5/8	3 3/16
5	9/16	1 1/16	1 5/8	2 3/16	2 11/15	3 1/4
6	9/16	1 1/8	1 1/16	2 1/4	2 13/16	3 3/8
7	9/16	1 3/16	1 3/4	2 5/16	2 7/8	3 1/2
8	5/8	1 3/16	1 13/16	2 3/8	3	3 5/8
9	5/8	1 1/4	1 7/8	2 1/2	3 1/8	3 3/4
10	5/8	1 5/16	1 15/16	2 5/8	3 1/4	3 7/8
11	11/16	1 3/8	2 1/16	2 11/16	3 3/8	4 1/16
12	11/16	1 7/16	2 1/8	2 13/16	3 9/16	4 1/4
13	3/4	1 1/2	2 3/16	2 15/16	3 11/16	4 7/16
14	3/4	1 9/16	2 1/4	3 1/16	3 13/16	4 5/8
15	13/16	1 5/8	2 3/8	3 3/16	4	4 13/16
16	13/16	1 11/16	2 1/2	3 5/16	4 3/16	5
17	7/8	1 3/4	2 5/8	3 7/16	4 5/16	5 3/16
18	7/8	1 13/16	2 11/16	3 5/8	4 1/2	5 7/16
19	15/16	1 7/8	2 13/16	3 3/4	4 11/16	5 5/8
20	1	1 15/16	2 15/16	3 7/8	4 7/8	5 13/16
21	1	2	3	4 1/16	5 1/16	6 1/16
22	1 1/16	2 1/16	3 1/8	4 3/16	5 1/4	6 1/4
23	1 1/16	2 3/16	3 1/4	4 5/16	5 3/8	5 7/16
24	1 1/8	2 1/4	3 3/8	4 1/2	5 9/16	6 11/16

TABLE 3

ADDITIONAL LENGTH IN INCHES TO ADD TO COMMON RAFTERS					
Rise	For Inches Additional Building Width				
	7	8	9	10	11
1	39/16	41/16	49/16	51/16	59/16
2	39/16	41/16	49/16	51/16	59/16
3	35/8	41/8	45/8	51/8	511/16
4	311/16	43/16	43/4	51/4	513/16
5	313/16	45/16	47/8	57/16	515/16
6	315/16	41/2	51/16	59/16	61/8
7	41/16	45/8	53/16	513/16	63/8
8	43/16	413/16	57/16	6	65/8
9	43/8	5	55/8	61/4	67/8
10	49/16	53/16	57/8	61/2	73/16
11	43/4	57/16	61/8	613/16	77/16
12	415/16	511/16	63/8	71/16	73/4
13	53/16	57/8	65/8	73/8	81/8
14	53/8	61/8	615/16	711/16	87/16
15	55/8	63/8	73/16	8	813/16
16	513/16	611/16	71/2	85/16	93/16
17	61/16	715/16	713/16	811/16	99/16
18	65/16	73/16	81/8	9	915/16
19	69/16	71/2	87/16	93/8	105/16
20	613/16	73/4	83/4	911/16	1011/16
21	71/16	81/16	91/16	101/16	111/16
22	75/16	83/8	93/8	107/16	111/2
23	79/16	85/8	93/4	1013/16	117/8
24	713/16	815/16	101/16	113/16	125/16

TABLE 4

ADDITIONAL LENGTH IN INCHES TO ADD TO HIP & VALLEY RAFTER						
Rise	For Inches Additional Building Width					
	1	2	3	4	5	6
1	11/16	17/16	21/8	213/16	39/16	41/4
2	11/16	17/16	21/8	27/8	39/16	41/4
3	11/16	17/16	21/8	27/8	39/16	45/16
4	3/4	17/16	23/16	215/16	35/8	43/8
5	3/4	11/2	23/16	215/16	311/16	47/16
6	3/4	11/2	21/4	3	33/4	41/2
7	3/4	11/2	29/16	31/16	313/16	49/16
8	13/16	19/16	23/8	31/8	315/16	411/16
9	13/16	15/8	23/8	33/16	4	413/16
10	13/16	15/8	27/16	35/16	41/8	415/16
11	13/16	111/16	21/2	33/8	43/16	51/16
12	7/8	13/4	25/8	37/16	45/16	53/16
13	7/8	113/16	211/16	39/16	47/16	53/8
14	15/16	113/16	23/4	311/16	49/16	51/2
15	15/16	17/8	213/16	33/4	43/4	511/16
16	15/16	115/16	27/8	37/8	413/16	513/16
17	1	2	3	4	5	6
18	1	21/16	31/16	41/8	51/8	63/16
19	11/16	21/8	33/16	41/4	55/16	63/8
20	11/16	23/16	31/4	43/8	57/16	39/16
21	11/8	21/4	33/8	41/2	55/8	63/4
22	13/16	25/16	31/2	45/8	513/16	615/16
23	13/16	23/8	39/16	43/4	6	71/8
24	11/4	21/2	311/16	47/8	61/8	73/8

TABLE 4

ADDITIONAL LENGTH IN INCHES TO ADD TO HIP & VALLEY RAFTER					
Rise	For Inches Additional Building Width				
	7	8	9	10	11
1	4 ¹⁵ / ₁₆	5 ¹¹ / ₁₆	6 ³ / ₈	7 ¹ / ₁₆	7 ¹³ / ₁₆
2	5	5 ¹¹ / ₁₆	6 ⁷ / ₁₆	7 ¹ / ₈	7 ¹³ / ₁₆
3	5	5 ³ / ₄	6 ⁷ / ₁₆	7 ³ / ₁₆	7 ⁷ / ₈
4	5 ¹ / ₁₆	5 ¹³ / ₁₆	6 ⁹ / ₁₆	7 ¹ / ₄	8
5	5 ³ / ₁₆	5 ⁷ / ₈	6 ⁵ / ₈	7 ³ / ₈	8 ¹ / ₈
6	5 ¹ / ₄	6	6 ³ / ₄	7 ¹ / ₂	8 ¹ / ₄
7	5 ³ / ₈	6 ¹ / ₈	6 ⁷ / ₈	7 ⁵ / ₈	8 ⁷ / ₁₆
8	5 ¹ / ₂	6 ¹ / ₄	7 ¹ / ₁₆	7 ¹³ / ₁₆	8 ⁵ / ₈
9	5 ⁵ / ₈	6 ³ / ₈	7 ³ / ₁₆	8	8 ¹³ / ₁₆
10	5 ³ / ₄	6 ⁹ / ₁₆	7 ³ / ₈	8 ³ / ₁₆	9
11	5 ⁷ / ₈	6 ³ / ₄	7 ⁹ / ₁₆	8 ⁷ / ₁₆	9 ¹ / ₄
12	6 ¹ / ₁₆	6 ¹⁵ / ₁₆	7 ¹³ / ₁₆	8 ¹¹ / ₁₆	9 ¹ / ₂
13	6 ¹ / ₄	7 ¹ / ₈	8	8 ¹⁵ / ₁₆	9 ¹³ / ₁₆
14	6 ⁷ / ₁₆	7 ⁵ / ₁₆	8 ¹ / ₄	9 ³ / ₁₆	10 ¹ / ₁₆
15	6 ⁵ / ₈	7 ⁹ / ₁₆	8 ¹ / ₂	9 ⁷ / ₁₆	10 ³ / ₈
16	6 ³ / ₄	7 ³ / ₄	8 ¹¹ / ₁₆	9 ¹¹ / ₁₆	10 ⁵ / ₈
17	7	8	9	10	11
18	7 ³ / ₁₆	8 ¹ / ₄	9 ¹ / ₄	10 ⁵ / ₁₆	11 ⁵ / ₁₆
19	7 ⁷ / ₁₆	8 ¹ / ₂	9 ⁹ / ₁₆	10 ⁵ / ₈	11 ¹¹ / ₁₆
20	7 ⁵ / ₈	8 ³ / ₄	9 ¹³ / ₁₆	10 ¹⁵ / ₁₆	12
21	7 ⁷ / ₈	9	10 ¹ / ₈	11 ¹ / ₄	12 ³ / ₈
22	8 ¹ / ₈	9 ¹ / ₄	10 ⁷ / ₁₆	11 ⁹ / ₁₆	12 ³ / ₄
23	8 ⁵ / ₁₆	9 ¹ / ₂	10 ¹¹ / ₁₆	11 ¹¹ / ₁₆	13 ¹ / ₈
24	8 ⁹ / ₁₆	9 ¹³ / ₁₆	11	12 ¹ / ₄	13 ¹ / ₂